

logitech®

TAP INTO BETTER MEETINGS.

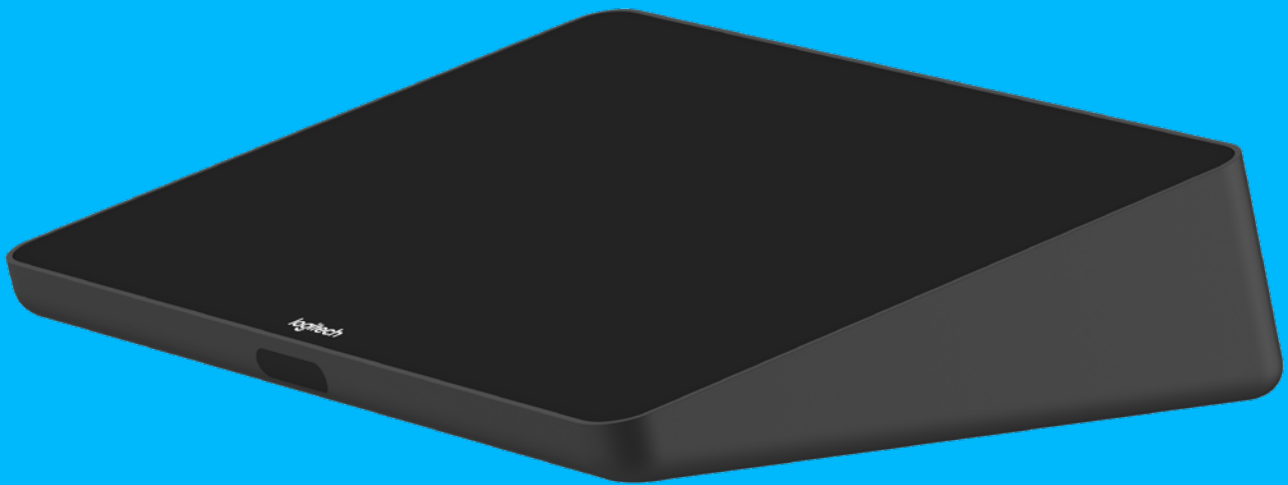

Logitech Tap

The Logitech® Tap touch-screen controller connects to any computer via USB, opening up new possibilities for applications like team collaboration, room automation, environmental control, and digital signage. Unlike AV controllers that require complex integration and installation, Logitech Tap offers plug-and-play connectivity as an additional display. Developers and system integrators can then design a touch-based

user interface to simplify workflows and automate tasks.

Boasting a crisp 10.1" touchscreen, low-profile enclosure, and multiple mounting accessories, Logitech Tap delivers a sleek appearance and convenient placement options that support a wide range of room sizes and layouts.

Logitech Tap is an ideal controller for video conferencing room solutions from Google®, Microsoft®, and Zoom. For more information about preconfigured Logitech room solutions for Hangouts™ Meet, Microsoft Teams Rooms and Skype® Room Systems, and Zoom Rooms, please visit www.logitech.com/Tap.

FEATURES & BENEFITS

Logitech Tap is designed for reliable performance in the workplace, with thoughtful features that deliver a great user experience. A range of mounts and the option to route cables out the back or from the bottom means you can deploy Tap at most any interior location.

- 1 10.1" touch display:** Spacious and responsive touch screen resists fingerprints and glare for high legibility and easy operation.
- 2 Silent enclosure:** The sleek, fan-free design provides a comfortable 14° angle for easy reading while creating space for connections, cables, and retention mechanisms.
- 3 Always-on readiness:** Built-in motion sensor saves power when idle, and powers on when a person approaches.
- 4 Headphone jack:** Extends the host computer's wired audio capabilities to the tabletop, ideal for private conversations and for the hearing-impaired.
- 5 Dual cable exits:** A sturdy metal cover with removable bottom and rear exits keep cables tidy and secure.
- 6 Built-in cable retention:** To keep connections tight, Tap features a comprehensive strain relief and retention system, hidden entirely within its enclosure.
- 7 USB accessory port:** Connect an accessory such as a USB speakerphone, or connect a second Tap for applications that support screen replication.
- 8 Multiple mounting options.** A built-in 100mm VESA pattern is compatible with thousands of third-party mounts and accessories. Optional table, riser, and wall mounts offer even more flexibility.
- 9 HDMI input for content sharing:** Provides instant wired content sharing when used with Google Hangouts Meet hardware, Microsoft Teams Room, and Zoom Rooms.
- 10 Anti-theft protection:** Keep Tap securely in place by connecting a security cable to one of Tap's two Kensington lock slots, one on the bottom and another at the back.
- 11 In-wall rated cabling:** The included 10m (32.8 ft) Logitech Strong USB cable offers high pull strength and is both plenum-rated and Eca certified for cable runs in walls, above ceilings, and through conduit.

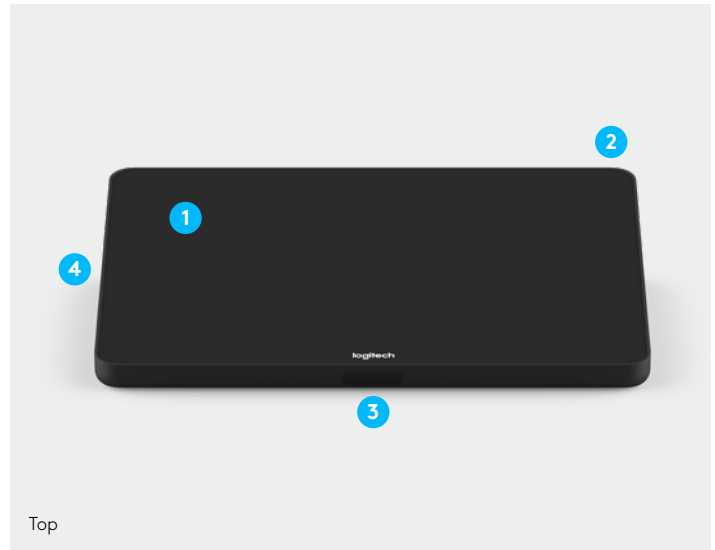

MOUNTING OPTIONS

With mounts and in-wall rated cabling that support a wide range of layouts and sizes, Logitech Tap lets you deploy the same user experience in every room. Secure in place, optimize cable routing, and add 180° rotation with Tap Table Mount. For better visibility in larger rooms, Tap Riser Mount elevates the screen to 30°. Tap Wall Mount frees valuable table space in small rooms. A built-in 100mm VESA pattern supports thousands of third-party mounts and accessories.

TABLE MOUNT



RISER MOUNT



WALL MOUNT



100mm VESA

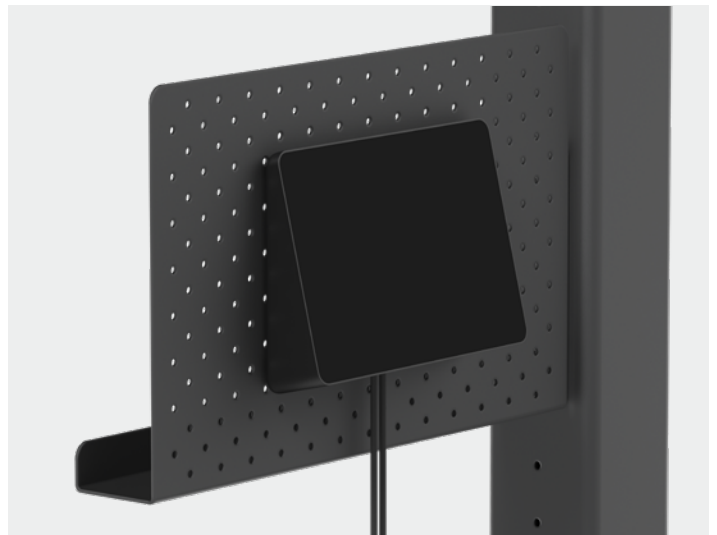

LOGITECH STRONG USB CABLE



The innovative Logitech Strong USB cable combines the plug-and-play ease of USB with the pull strength and in-wall ratings of specialized cabling. At 10 meters (32.8 ft), the included Logitech Strong USB cable delivers twice the length of the longest ordinary USB cables. And because Logitech Strong USB is aramid-reinforced, plenum-rated, and Eca certified, you can hide cabling in walls, above ceilings, or within standard 3/4" conduit.

Logitech Strong USB is also available in 25 meter (82 ft) length for larger rooms and longer runs.

- 1 In-Wall Rated:** Plenum-rated and Eca compliant for in-wall and conduit runs.
- 2 Tight Connection:** Works with the Tap cable retention system to keep connections tight.
- 3 High Durability:** Aramid-reinforced for high pull-strength and durability.

LOGITECH TAP TECHNICAL SPECIFICATIONS

PRODUCT DIMENSIONS

Total Height x Width x Depth:
58 x 244 x 179 mm
2.3 x 9.6 x 7.0 in
1.25 kg (2.75 lbs)

TOUCH SCREEN

10.1" diagonal screen with 14° display angle
Oleophobic and anti-glare coating
1280 x 800 resolution

SYSTEM REQUIREMENTS

Windows® 10
Chrome OS™
USB 2.0, 3.0, or 3.1 Type A port

OPTIONAL ACCESSORIES

Table Mount
Riser Mount
Wall Mount
PC Mount
Logitech Strong USB cable: 10m cable included,
25m optional

PORTS AND INTERFACES

USB 2.0/3.0/3.1 Type C (to PC)
USB 2.0/3.0/3.1 Type A (for accessory
connection)
HDMI input (for content sharing)
3.5mm/1/8" 4 pole Headset Jack
Integrated ultrasonic speaker
Integrated PIR Motion Sensor
100mm x 100mm VESA FDMI (Flat Display
Mounting Interface)
Kensington Lock Slots (2)

COMPATIBILITY AND CERTIFICATIONS

Logitech Tap is certified as a touch controller for
video conferencing room solutions:

Google Hangouts Meet
Microsoft Teams Rooms and Skype Room
Systems (SRS)
Zoom Rooms

DisplayLink® Plug and Display™: Tap connects
via USB as an additional display for supported
operating systems, including Windows 10 and
Chrome OS

INSIDE THE BOX

Tap Touch Controller
Logitech Strong USB 2.0/3.0/3.1 Cable
10m (32.8 ft)
Type A (male) to Type C (male)
Aramid-reinforced
Plenum Rated
Eca/IEC 60332-1-2 Compliant
3/4" Conduit friendly
HDMI 1.4a cable 2.0m/6.5 ft
Power adaptor with regional plugs (100-240v)
2.95m/9.67 ft
VESA Mounting Screws (4)
Microfiber Cloth
Documentation

WARRANTY

2-year limited hardware

PART NUMBERS AND UPC

Part #: 939-001796
UPC: 97855147400

ROOM SOLUTIONS WITH LOGITECH TAP

Video conferencing room solutions with Logitech Tap deliver calendar integration, touch-to-join, instant content sharing, and always-on readiness. Pre-configured with room-optimized software from Google, Microsoft, or Zoom, Logitech Room Solutions include all necessary components: Tap touch controller, small form factor computer, in-wall rated cabling, and Logitech MeetUp or Rally conference camera. Learn more at www.logitech.com/tap.



www.logitech.com/tap

Logitech Inc. 7700 Gateway Blvd., Newark, CA 94560
Published January 2019

© 2019 Logitech. Logitech, the Logitech logo and other Logitech marks are owned by Logitech and may be registered. All other trademarks are the properties of their respective owners. Logitech assumes no responsibility for any errors that may appear in this publication. Product, pricing and feature information contained herein is subject to change without notice.

logitech®

TAP ACCESSORIES



Logitech Tap Accessories

With its 10.1" touch screen, Logitech Tap brings friendly touch controls to compatible video conferencing and collaboration applications. And thanks to a range of mounting and cabling options, you can integrate and secure Tap in almost any room, with the meeting room computer safely out of the way.

Designed for conference room tables with grommets, the Table Mount secures Tap in place while maintaining a low profile. For larger rooms,

choose the Riser Mount, which raises Tap from 14° to 30° for better visibility from across the room. Both mounts support through-grommet cabling for a clean appearance and swivel 180° for convenient operation from both sides of the table.

In hallways and smaller rooms, choose the Wall Mount for stand-up operation and to preserve table space. Tap is even designed with a 100mm VESA pattern for compatibility with thousands of third-party mounts and accessories.

Wherever you install Tap, the in-wall rated Logitech Strong USB cable offers convenient and robust cable routing. Available in 10 and 25 meter (32.8 and 82 ft) lengths, Logitech Strong USB offers up to 5x the length of ordinary USB cables so you can mount Tap and the meeting room computer almost anywhere. And because Logitech Strong USB is aramid-reinforced, plenum-rated, and Eca certified, you can hide cabling in walls, above ceilings, or within standard ¾" conduit.

FEATURES & BENEFITS

TABLE MOUNT

- 1 Low-Profile with Pivot:** Preserves Tap's sleek appearance and 14° screen angle while swiveling 180° for user convenience.
- 2 Fits Most Tables:** Adjusts to tables up to 50mm (2 in) in thickness, and through grommets from 51 - 89mm (2 - 3.5 in) in diameter.



- 3 Cable Management:** Supports down-routing of cables through the grommet for a clean appearance.



RISER MOUNT

- 1 Raised Profile with Pivot:** Elevates Tap to a 30° screen angle for better visibility in larger rooms, while swiveling 180° for user convenience.
- 2 Fits Most Tables:** Adjusts to tables up to 50mm (2 in) in thickness, and through grommets from 51 - 89mm (2 - 3.5 in) in diameter.



- 3 Cable Management:** Supports down-routing of cables through the grommet for a clean appearance.

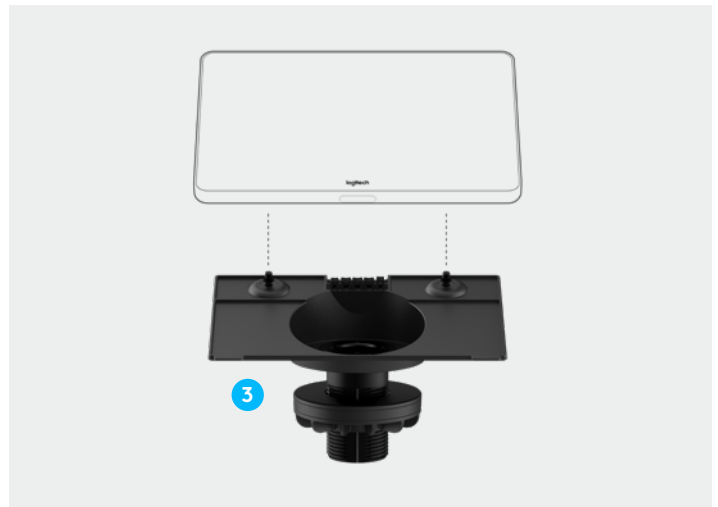

WALL MOUNT

- 1 Flush Mounts to Any Wall:** The plate and cleat construction adds virtually no thickness for a sleek appearance.
- 2 HDMI Cable Cinch:** Hang an HDMI cable for easy access when deployed with applications that support wired content sharing.

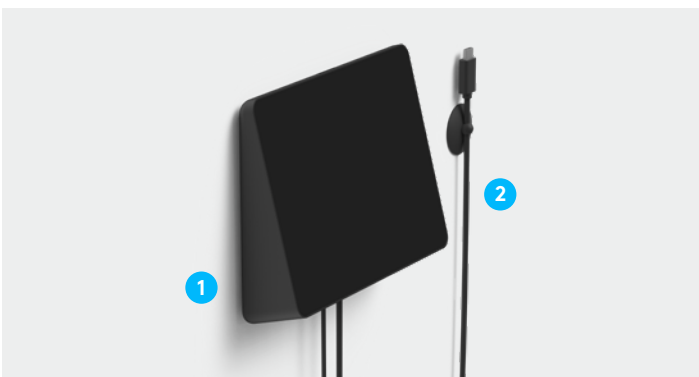

- 3 In-Wall Cabling:** Supports Tap's rear and bottom cable exits so you can route cabling either within or down the wall.

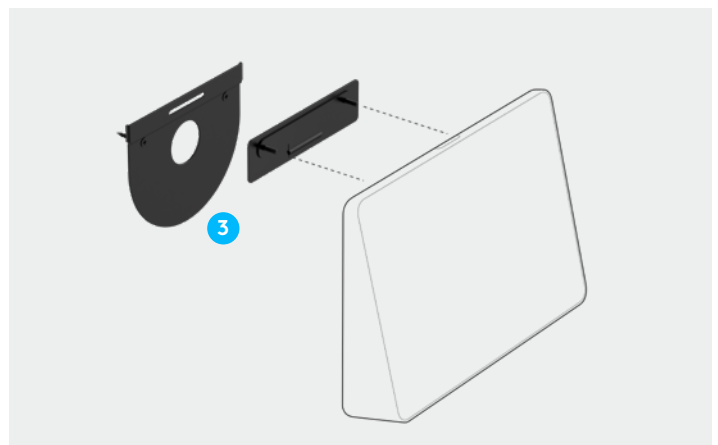

PC MOUNT

- 1 Cable Retention:** Two-piece cable retention clamp relieves strain and keeps USB, HDMI, power, and network cables tight and secure.
- 2 Fits Most SFF PCs:** Robust steel mount fits small form factor (SFF) computers and mounting plates with a 75mm or 100mm VESA pattern.



- 3 Hideaway Design:** Includes hardware to mount a PC behind a display on the wall, or beneath a table.

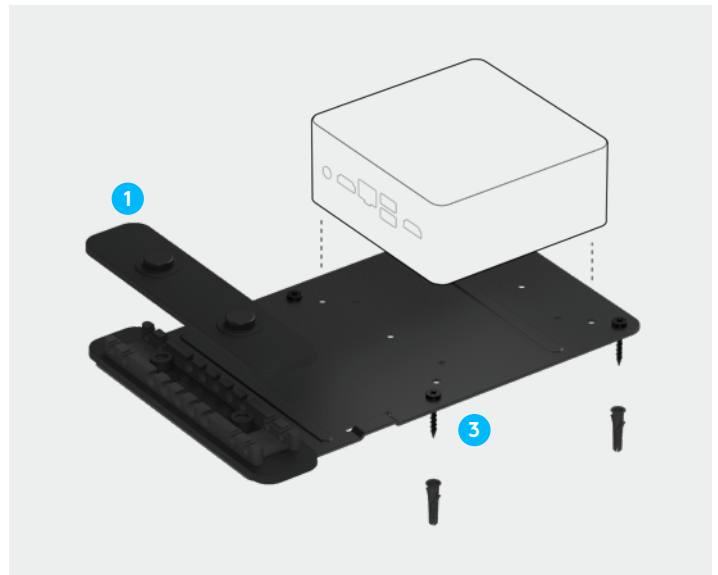

LOGITECH STRONG USB CABLE



- 1 In-Wall Rated:** Aramid-reinforced, plenum-rated and Eca compliant for high pull-strength and durability in walls, above ceilings, or within standard 3/4" conduit.
- 2 Stays Connected:** Together with Tap's internal cable retention and strain relief systems, Logitech Strong USB stays securely connected, even when users move Tap around the room.
- 3 Compatible:** With support for USB 3.1, 3.0, and 2.0, the active optical cable is compatible with self-powered USB Type C devices like MeetUp and Rally Camera, or any USB Type C hub with its own power supply.
- 4 Hides the Computer:** Available in 10 and 25 meter (32.8 and 82 ft) lengths so you can move the meeting room computer — and its noise, heat, and cabling — away from participants and out of sight.

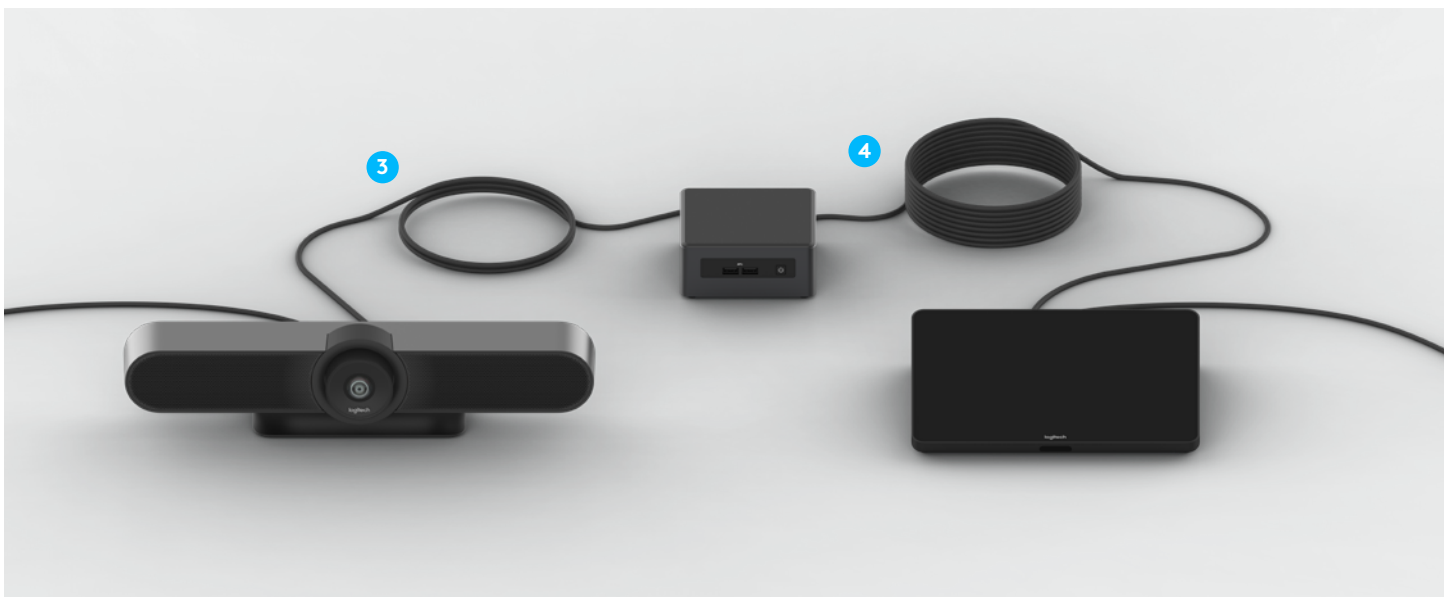

TABLE MOUNT**Product Dimensions**

Tap with Table Mount
2.4 x 9.6 x 7.0 in
61 x 244 x 179 mm

Compatibility

Logitech Tap
Table Thickness: 0.75 - 2.0 in (20 - 50 mm)
Grommet Diameter: 2.0 - 3.5 in (51 - 89 mm)

Inside the Box

Table Mount Assembly
Cable Cinch
Documentation

Warranty

2-year limited hardware

Part Numbers and UPC

Part #: 939-001811
UPC: 97855147325

RISER MOUNT**Product Dimensions**

Tap with Riser Mount
2.4 x 9.6 x 6.9 in
102 x 244 x 174 mm

Compatibility

Logitech Tap
Table Thickness: 0.75 - 2.0 in (20 - 50 mm)
Grommet Diameter: 2.0 - 3.5 in (51 - 89 mm)

Inside the Box

Riser Mount Assembly
Cable Cinch
Documentation

Warranty

2-year limited hardware

Part Numbers and UPC

Part #: 939-001814
UPC: 97855147332

WALL MOUNT**Product Dimensions**

Tap with Wall Mount
2.3 x 9.6 x 7.0 in
58 x 244 x 179 mm

Compatibility

Logitech Tap

Inside the Box

Wall Mount Assembly (plate and cleat)
HDMI Cable Clip
Mounting Hardware
Documentation

Warranty

2-year limited hardware

Part Numbers and UPC

Part #: 939-001817
UPC: 97855147349

PC MOUNT**Product Dimensions**

PC Mount with Cable Retention Clamp
1.02 x 6.46 x 9.84 in
26 x 164 x 250 mm

Compatibility

Small form factor (SFF) computer with
75 x 75 mm or 100 x 100 mm VESA pattern

Inside the Box

PC mount
VESA Mounting Plate
Cable Retention Clamp
Mounting Hardware
Documentation

Warranty

2-year limited hardware

Part Numbers and UPC

Part #: 939-001825
UPC: 97855148100

LOGITECH STRONG USB CABLE**Product Specifications**

USB Type A (male) to USB Type C (male)
active optical cable
Aramid-reinforced sheath
3/4" conduit friendly

Product Dimensions

Available Lengths:
10m (32.8 ft)
25m (82 ft)

Compatibility

USB 2.0/3.0/3.1
Logitech Tap
Logitech MeetUp
Logitech Rally Camera
Self-powered USB 2.0/3.0/3.1 hubs and devices
with external power supplies
*Not compatible with Logitech BRIO and other
USB bus-powered devices*

Certifications

Plenum Rated
Eca/IEC 60332-1-2 Compliant

Inside the Box

Logitech Strong USB-A to USB-C Cable: 10 or
25 meters (32.8 or 82 ft)
USB-C extension cable for tight spaces:
152 mm (6 in)
Documentation

Warranty

2-year limited hardware

Part Numbers and UPC

10 Meter
Part #: 939-001799
UPC: 97855147097

25 Meter

Part #: 939-001802
UPC: 97855147103

