

DaVinci Resolve Mini Panel



\$2,115

A compact professional hardware control panel featuring 3 high resolution weighted trackballs, 12 control knobs for essential tools and an upper deck with two 5" screens, DaVinci Resolve Mini Panel has 8 soft knobs and 8 soft buttons, and dedicated keys for switching tools, working with nodes, grabbing stills, navigating the timeline and more!

Connections

Computer Interface

USB Type-C.

Ethernet

1 x Ethernet connection supporting 10/100/1000 BaseT with PoE.
 1 x Ethernet connection supporting 10/100/1000 BaseT.

Power

1 x IEC C14 mains input.
 1 x +12V DC 4-pin XLR.
 1 x Ethernet with PoE.

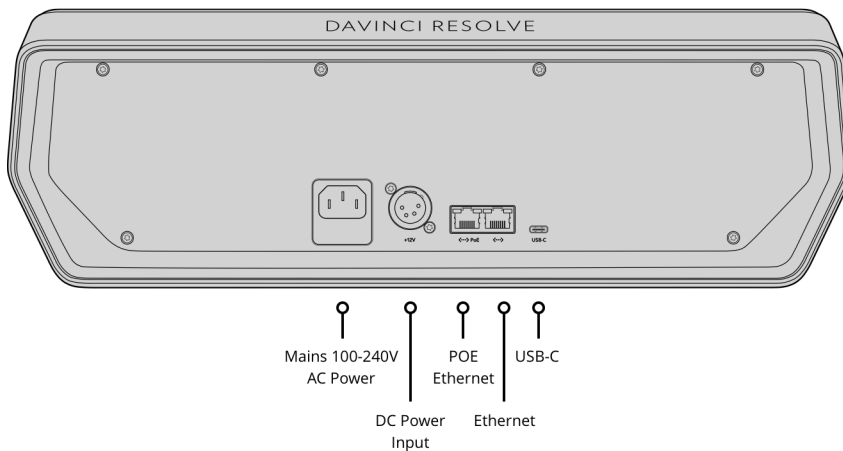

Power Requirements

Power Supply

Internal 100 - 240V AC 1.5A 50/60Hz with IEC C14 mains input.

Power Usage

17W max.

Operating Systems



Mac 10.15 Catalina or later.



Windows 10, 64-bit.



Linux CentOS 7.3 or later.

Physical Specifications



Environmental Specifications

Operating Temperature

0° to 40°C (32° to 104°F)

Storage Temperature

-20° to 60°C (-4° to 140°F)

Relative Humidity

0% to 90% non-condensing

What's Included

DaVinci Resolve Mini Panel

DaVinci Resolve Studio activation key

Warranty

1 Year Limited Manufacturer's Warranty.

All items on this website are copyright Blackmagic Design Pty. Ltd. 2022, all rights reserved. All trademarks are property of their respective owners. MSRP includes duties, but excludes sales tax and shipping costs. This website uses remarketing services to advertise on third party websites to previous visitors to our site. You can opt out at any time by changing cookie settings. [Privacy Policy](#)

Blackmagic Design Authorized Reseller